

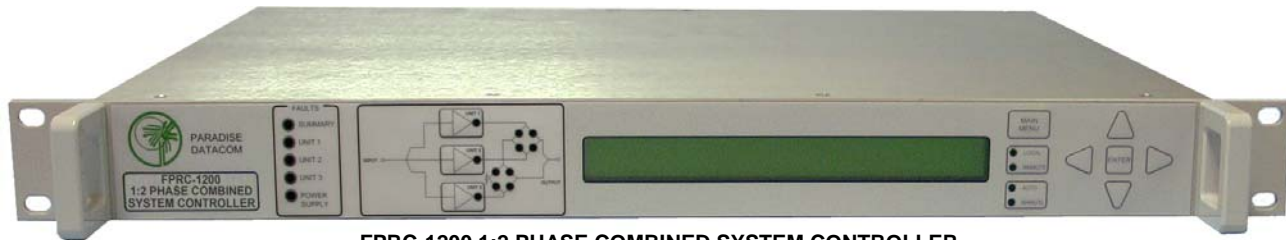

**RCP2-1100 1:1 REDUNDANT SYSTEM CONTROLLER**



**FPRC-1200 1:2 PHASE COMBINED SYSTEM CONTROLLER**

## Description:

The Paradise Datacom family of Redundant System Controllers is used to monitor and control amplifiers configured in 1:1 and 1:2 redundant systems.

The RCP2-1100 and FPRC-1100 controllers provide control of two amplifiers and their corresponding transfer switch. The RCP2-1200 and FPRC-1200 controllers monitor and control three amplifiers and two switches.

The RCP2/FPRC Series of redundant controller can be used in LNA, LNB, and SSPA systems as well as frequency converter systems. They feature a full mimic panel and menu-driven LCD display all in one rack unit of cabinet space.

Front panel fault lights and an audible alarm are available for fault detection.

Completely redundant power supplies are incorporated with universal input and power factor correction. System control is available through the front panel (local mode), or through the rear panel parallel I/O remote, or serial I/O remote modes.

The use of flash memory allows easy field programmable firmware updating.

## FEATURES

- Menu Driven LCD for user friendly monitor and control
- Front Panel Display of Signal Path for intuitive operation
- Parallel I/O; Form C Contact Closure Outputs & Opto-Isolated Inputs
- 1 Rack Unit height to maximize cabinet space
- RS-232/485 Serial Interface for Remote M&C
- Audible alarms
- Field programmable firmware
- Windows™ based remote M&C Software
- Ethernet Port

## OPTIONS

- Remote Control Panel
- Control Panels for Phase Combined SSPA Systems
- Adapter cables for compatibility with previous generation systems
- DC Operation

### FRONT PANEL DESCRIPTION

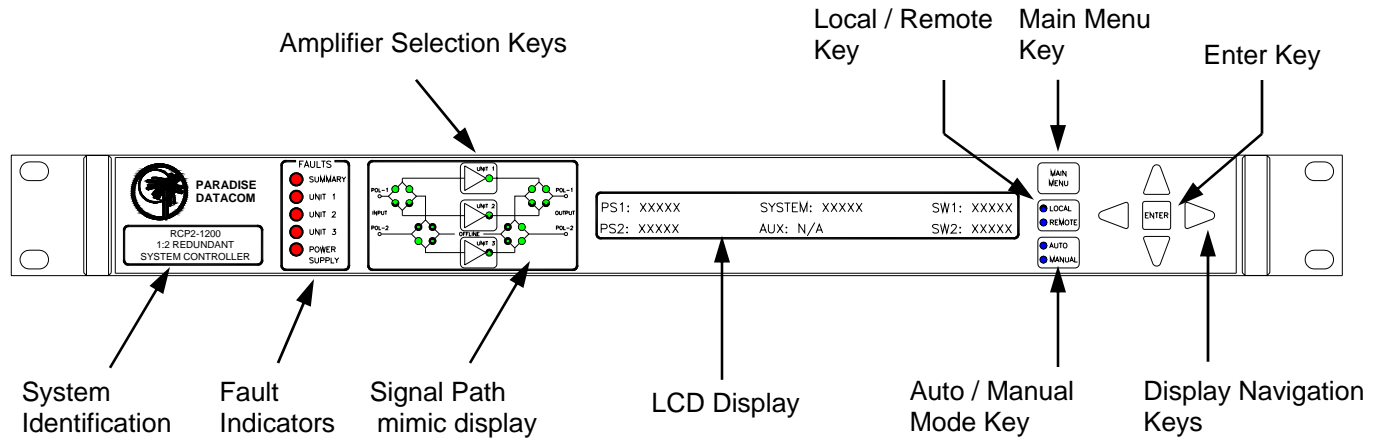

### GENERAL SPECIFICATIONS

Characteristic	Specification
Configurations	RCP2-1100 ; 1:1 Redundant System
	RCP2-1200 ; 1:2 Redundant System
	FPRC-1100 ; 1:1 Redundant / Phase Combined System
	FPRC-1200 ; 1:2 Fixed Phase Combined System
Switch Time	Fault Detection, 20 - 50 msec
	Total Switchover (including mechanical switch) - 100 msec maximum
Switch Drive	26 VDC @ 5 Amps
Alarm Input	Closure to Ground, (Ground=OK / Open=Fault)
Serial Communication	RS232 / RS485 4 wire
Parallel I/O	
Status Outputs	Form C Relay Contacts (10 sets)
Control Inputs	Contact Closure to Ground
AC Input Power	85—265 VAC, 47-63 Hz, 1 A max, > 0.93 power factor
DC Input Power (48 VDC Input Option)	36-72 VDC, Maximum DC Input current @ 48V - 2 Amps
Mechanical	
Dimensions	1.75 in. H x 19.0 in. W x 13.3 in D [1RU] 44.5 mm H x 483 mm W x 338 mm D
Weight	5 lbs. (2.3 kg)
Temperature	0 to 50 °C operating (non-condensing)

### FAULT INDICATORS

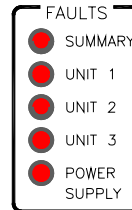
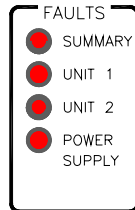

The image on the left shows the fault indicators for RCP2-1100 and FPRC-1100 models; the figure to the right shows the fault indicators for RCP2-1200 and FPRC-1200 models.

### SIGNAL PATH MIMIC DISPLAYS

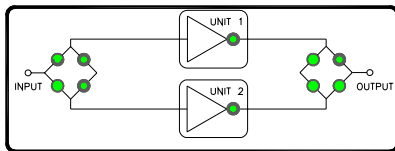

**RCP2-1100**  
**1:1 Redundant System Controller**

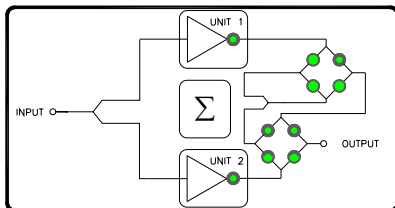

**FPRC-1100**  
**1:1 Phase Combined System Controller**

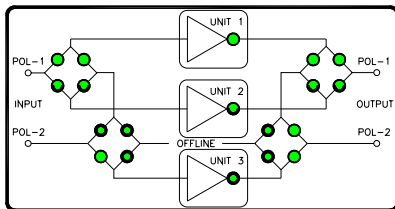

**RCP2-1200**  
**1:2 Redundant System Controller**

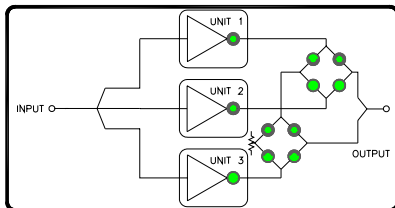

**FPRC-1200**  
**1:2 Phase Combined System Controller**

### REAR PANEL CONNECTORS AND PIN IDENTIFICATION

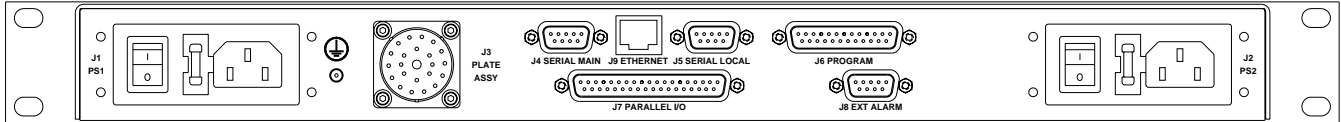

#### J1, J2 - Power Supply Requirements

ID	Input Voltage Range	Line Frequency	Input Power	Power Factor
J1	85-265 VAC	47-63 Hz	100 W	.93
J2	85-265 VAC	47-63 Hz	100 W	.93
J1, J2	36-72 VDC	Max. DC Input Current @ 48V - 2A		

#### J1, J2 - DC Input Option Pin Outs

Pin	Function
A	+ 48 VDC
B	+ 48 VDC
C	- 48 VDC
D	- 48 VDC
E	Ground
F	Ground

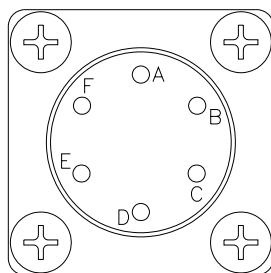

**MS3112E10-6P**  
Mates to MS3116F10-6S

#### J3 - Switch Connector, MS3112E16-23S

Pin	Function
L	Power Supply #1 +12-20 VDC, 1A or +26V, 3A
J	Power Supply #2 +12-20 VDC, 1A or +26V, 3A
G	Power Supply #3 +12-20 VDC, 1A or +26V, 3A
E,D	Switch Common, +26 VDC, 5A max
W,U	Switch #1 Position 1 (Tx)
P,S	Switch #1 Position 2 (Tx)
F,H	Switch Common, +26 VDC, 5A max
T,V	Switch #2 Position 1 (Rx)
N,R	Switch #2 Position 2 (Rx)
A,B,C	AMP Support GND
K,M	Switch Common, +26 VDC, 5A max

#### J4 - Serial Port (Main) Pin Out

Pin	Function
1	RS485 TX+
2	RS232 Out or RS485 TX-
3	RS232 In or RS485 RX-
4	RS485 RX+
5	Ground
6	Service Request 1
8	Service Request 2
7	Service Request Common
9	Termination (120 Ohm)

#### Rear Panel Connectors and Pin Identification, DC Option

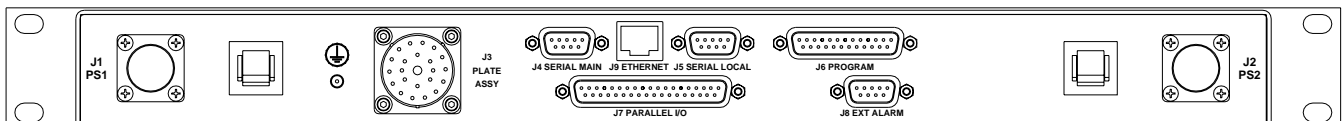



### J5 - Serial Local Pin-out (For Remote SSPA Control)

Function	Pin	Notes
RS485 RX+	1	
RS485 RX-	2	
RS485 TX-	3	
RS485 TX+	4	
Ground	5	
Termination (120 Ohm)	9	Connect to pin 1 to terminate unit on end of bus

### J8 - External Alarm Pin-out

Function	Pin	Notes
External Alarm 1	1	Closure to Ground, 5mA max short circuit current, 5 VDC open circuit voltage
External Alarm 2	2	
External Alarm 3	3	
Ground	4,8,9	
Auxiliary Alarm 1	5	Closure to Ground, 5mA max short circuit current, 5 VDC open circuit voltage
Auxiliary Alarm 2	6	
Auxiliary Alarm 3	7	

### J9 - Ethernet Port Pin-out

Pin	Notes
1	TX+
2	TX-
3	RX-
6	RX+
4,5,7,8	GND

### J7 - Parallel I/O Connector Pin-out

Identification	Signal	Pin	Function	Notes
Amp 1 Alarm	Output	1	Closed on Fault	Relay Contacts: 30 VDC @ 0.5A
		20	Common	
		2	Open on Fault	
Amp 2 Alarm	Output	21	Closed on Fault	Relay Contacts: 30 VDC @ 0.5A
		3	Common	
		22	Open on Fault	
Amp 3 Alarm	Output	4	Closed on Fault	Closed on Phase Combined Mode
		23	Common	
		5	Open on Fault	Open on Phase Combined Mode
Auto / Manual Mode	Output	24	Closed on Manual	
		6	Common	
		25	Closed on Auto	
Local / Remote Mode	Output	7	Closed on Local	
		26	Common	
		8	Closed on Remote	
Switch #1 Position	Output	27	Switch #1, Position 1	
		9	Common	
		28	Switch #1, Position 2	
Switch #2 Position	Output	10	Switch #2, Position 1	
		29	Common	
		11	Switch #2, Position 2	
Power Supply #1 Alarm	Output	30	Closed on Fault	
		12	Common	
		31	Open on Fault	
Power Supply #2 Alarm	Output	13	Closed on Fault	
		32	Common	
		14	Open on Fault	
Priority Setting	Output	33	Closed on Priority 2	
		15	Common	
		34	Closed on Priority 1	
Auxiliary Input	Input	16	Ground to Activate	5mA max current on all inputs
Priority Select	Input	17	Ground to Activate	Toggle Function
Auto / Manual	Input	18	Ground to Activate	Toggle Function
Amp 3 Standby	Input	35	Ground to Activate	
Amp 2 Standby	Input	36	Ground to Activate	
Amp 1 Standby	Input	37	Ground to Activate	
Inputs Ground	Common	19		(isolated)